

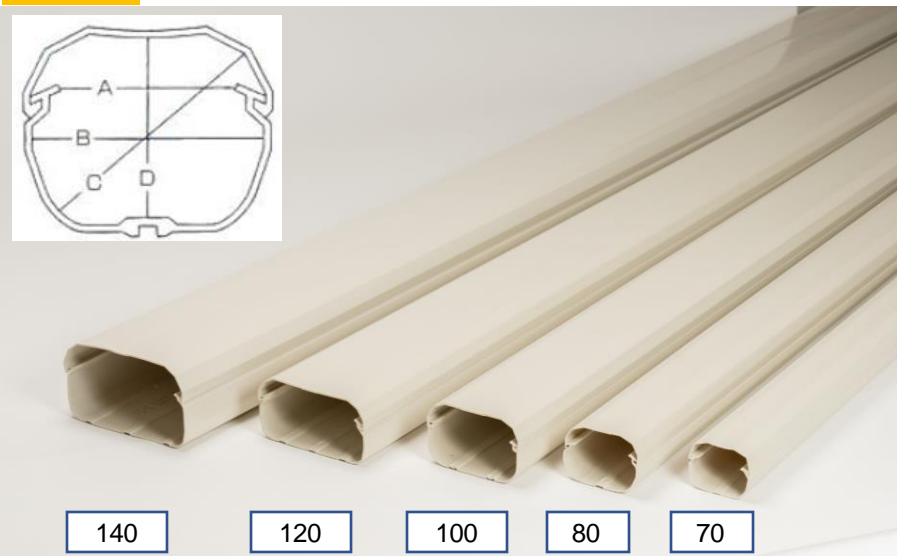

70 series : white is not available  
100, 120, 140 series : only Ivory is available

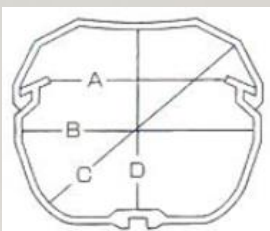

## TD Duct – Main Unit



### Features;

- Made from high grade PolyVinyl Chloride (PVC) resin which has excellent durability and weather resistance.
- Slim, square design and various fittings will make any installation lovely and looks clean and professional.

### Notes for usage;

- As the ducts do not have water proof, contact point on the wall, joint, screw hole etc... should be filled by caulking compound or putty.
- Not able to use where surface temperature beyond the range -20 to 60°C.

Model No.	Size (mm)					Package Qty
	A	B	C	D	Length	
TD-70	42	57	63	48	2,000	5pcs × 3c/s
TD-80	60	73	78	58	2,000	5pcs × 3c/s
TD-100	82	98	103	68	2,000	4pcs × 2c/s
TD-120	114	120	125	68	2,000	4pcs × 2c/s
TD-140	128	148	155	85	2,000	4pcs × 2c/s

## DL Duct Elbow

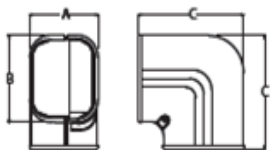

Model No.	Size (mm)			Package Qty
	A	B	C	
DL-70	73	59	100	20
DL-80	86	70	113	20
DL-100	110	78	157	12
DL-120	130	81	176	10
DL-140	163	98	220	6

## DLW Duct Elbow 45°

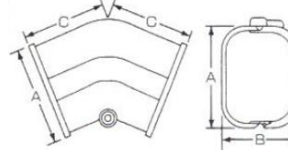

Model No.	Size (mm)			Package Qty
	A	B	C	
DLW-70	73	59	60	20
DLW-80	86	73	69	20

## DJ Duct Joint

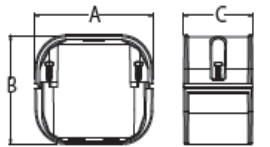

Model No.	Size (mm)			Package Qty
	A	B	C	
DJ-70	73	59	50	50
DJ-80	86	70	50	50
DJ-100	110	78	65	25
DJ-120	130	81	79	20
DJ-140	161	98	89	10

## DS Soffit Inlet

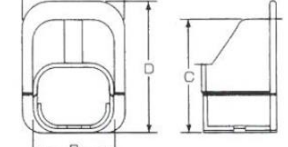

Model No.	Size (mm)				Package Qty
	A	B	C	D	
DS-80	107	86	120	139	20
DS-100	130	110	126	150	20
DS-120	159	136	135	159	10
DS-140	186	163	150	170	6

## DK Vertical Duct Elbow

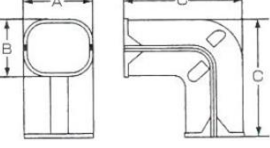

Model No.	Size (mm)			Package Qty
	A	B	C	
DK-70	73	59	120	20
DK-80	86	70	120	20
DK-100	110	78	121	20
DK-120	129	85	130	6
DK-140	161	98	140	6

## DIK Vertical Duct Elbow Mini

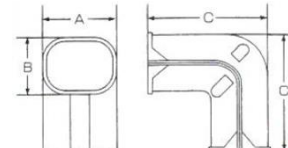

Model No.	Size (mm)			Package Qty
	A	B	C	
DIK-80	86	70	103	20

## DC Wall Inlet Cover

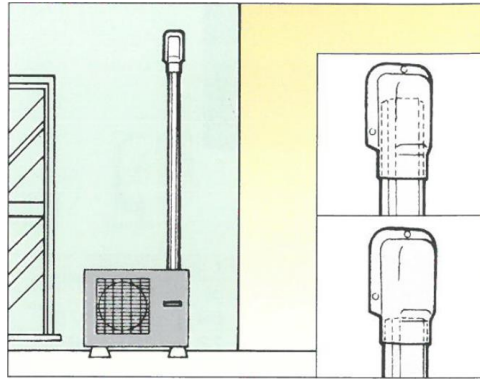
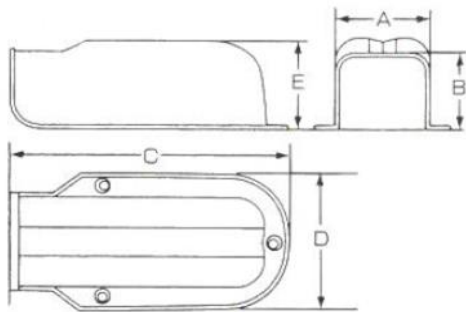

Cover the wall hole with duct cap

Model No.	Size (mm)					Package Qty
	A	B	C	D	E	
DC-70	68	57	197	97	66	20
DC-80	81	68	211	111	82	20
DC-100	110	78	225	145	90	16
DC-120	128	80	260	164	110	10
DC-140	162	95	291	197	131	6

## DIS Conversion Socket

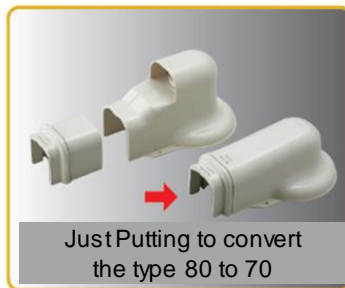
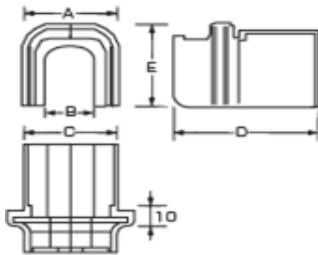

Just Putting to convert the type 80 to 70

Model No.	Size (mm)					Package Qty
	A	B	C	D	E	
DIS-70-80	81	63	75	85	68	50

• Material : PolyVinyl Chloride (PVC)

## DT Duct Tees

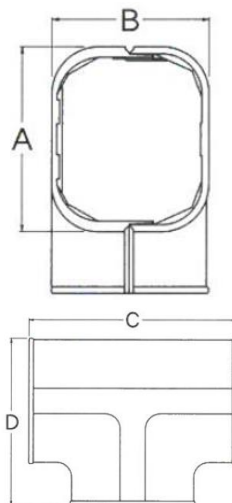

Model No.	Size (mm)				Package Qty
	A	B	C	D	
DT-80	84	71	140	112	10
DT-120	130	81	243	185	5

DT-120 including two pcs reducer DR-120

## DR Duct Reducer

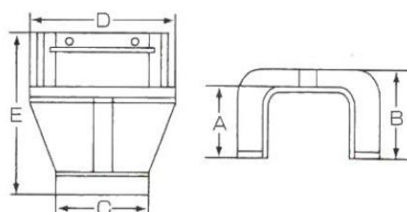

Model No.	Size (mm)					Package Qty
	A	B	C	D	E	
DR-120	68	81	86	130	148	10

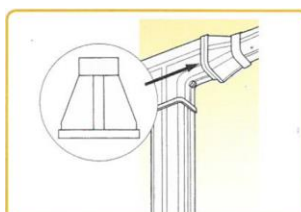

## DHC / DHBC Wall Inlet Ventilation Cap Mini / Big

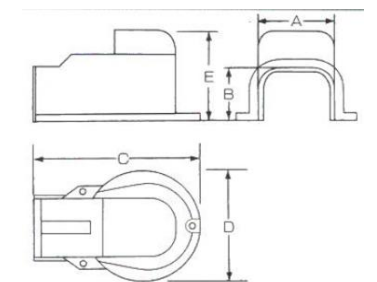
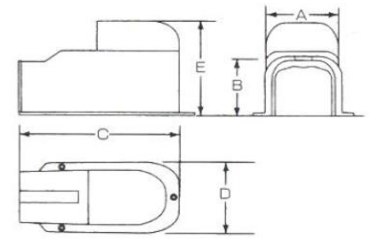

Model No.	Size (mm)					Package Qty
	A	B	C	D	E	
DHC-80	81	68	207	109	128	10
DHBC-80	81	68	228	155	128	10

• Material : Polycarbonate

## DIC / DBC Wall Inlet Cap / Round Wall Inlet Cap

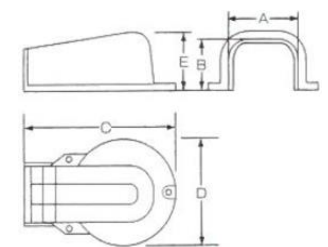
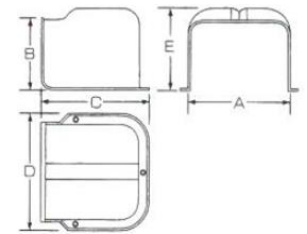
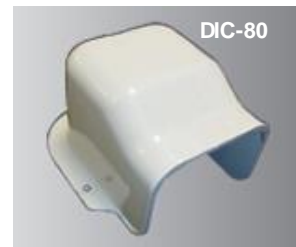

Model No.	Size (mm)					Package Qty
	A	B	C	D	E	
DIC-80	81	68	120	111	82	20
DBC-80	81	68	215	155	82	20

• Material : Polycarbonate

## DE Duct - End Cap

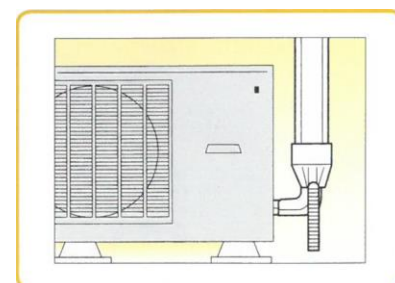
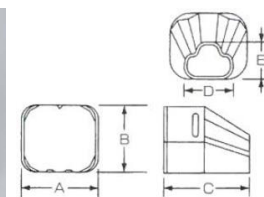

For fitting end

Model No.	Size (mm)					Package Qty
	A	B	C	D	E	
DE-70	73	59	94	52	35	20
DE-80	86	70	95	52	45	20

## DF Flexible Duct – 2m length

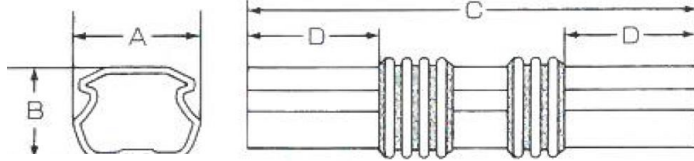
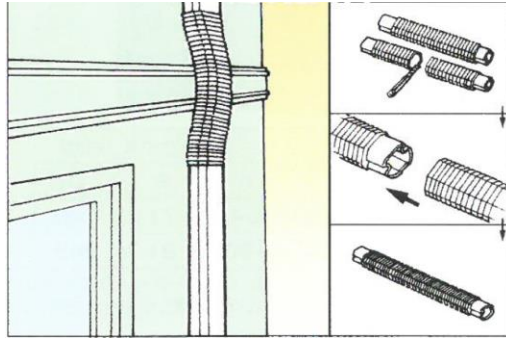

Model No.	Size (mm)				Package Qty
	A	B	C	D	
DF-70S	59	50	633	75	20
DF-70L	59	50	1,200	75	15
DF-80	75	60	630	84	10
DF-80S	75	60	633	75	20
DF-80L	75	60	1,200	75	15
DF-100	95	65	780	78	8
DF-120	122	70	800	82	5
DF-140	140	85	918	86	4

• Material : Polyethylene

## DSS Stainless Saddle



When use long flexible duct DF-70L or DF-80L, Recommend to use this saddle to fix like below picture.

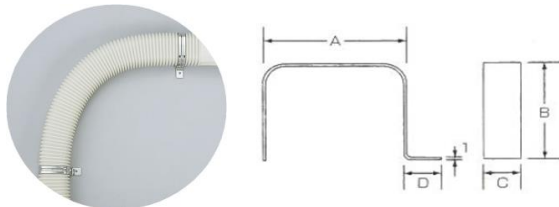

Model No.	Size (mm)				Package Qty
	A	B	C	D	
DSS-70	62	51	18	25	50
DSS-80	79	61	18	25	50

• Material : Stainless

## DHK Duct Support Bracket (for horizontal line set)

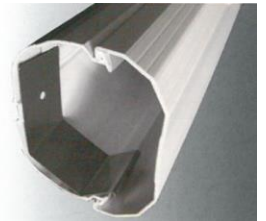
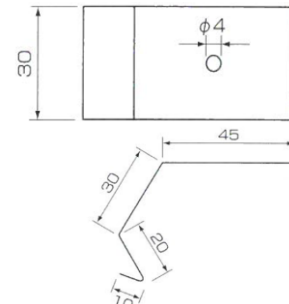
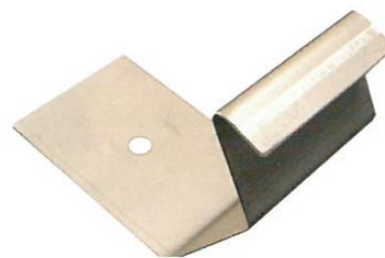

Bracket part made of SUS 304 to prevent duct deforming and falling of duct cover in horizontal line setting.

Recommended usage interval : about 50cm in duct

Model Number	Qty
DHK-80	20/bag

• Material : SUS 304

## FS Flexible Saddle



Model No.	Qty (pc x bag)
FS-10	10 x 100
FSS-10 (incl. screws)	10 x 100

Applicable Pipe diameter 38φ~55φ.

## KH Wall Sleeve Hole Cap

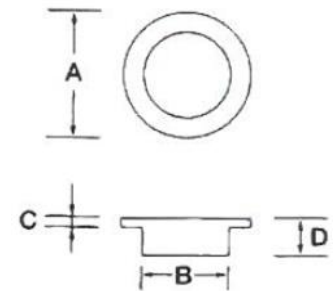

Model No.	Size (mm)				Adaptive Hole Size (mm)	Adaptive Wall Thickness (mm)	Package Qty
	A	B	C	D			
KH-60	110	60	5	30	60~100φ	50~250	50

※Ivory and white color are available for the coordination with wall color.

## WC Wall Sleeve Cap / Thin Version

## WCF Lid

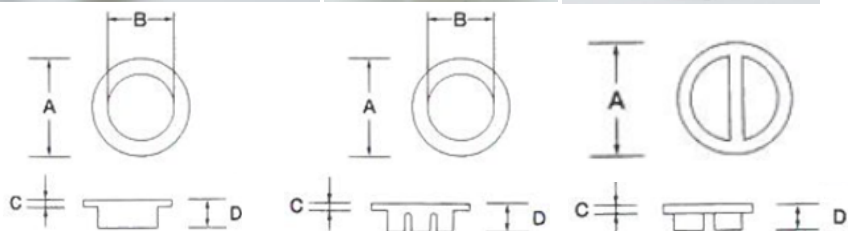
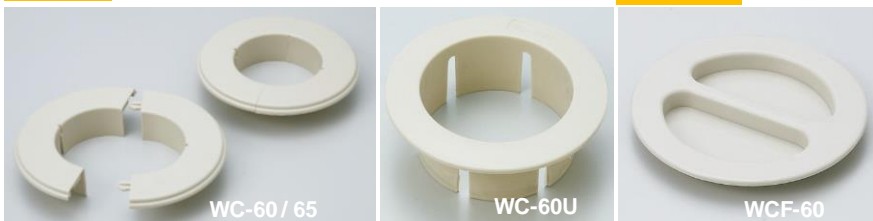

Model No.	Core Drill Diameter	Size (mm)				Package Qty
		A	B	C	D	
WC-60	65φ	110	60	6	25	200
WC-65	70φ	110	65	5	28	200
WC-60U	65φ	85	58	2	26	200
WCF-60	-	76	-	1	8	200

Color: Ivory

## WP Wall Pipe

## WKP With Flange

## WFP With Flange Flexible ver.

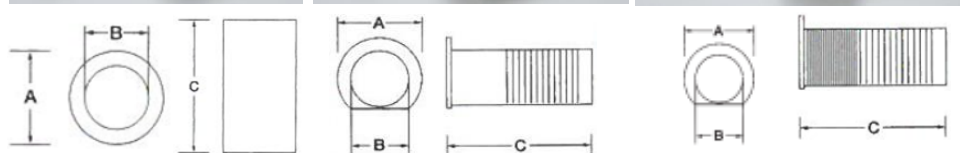

Model No.	Core Drill Diameter	Size (mm)			Package Qty
		A	B	C	
WP-60	65φ	63	61	160	100
WP-65	70φ	69	67	200	50
WKP-60	65φ	84	61	210	100
WKP-65	70φ	89	66	210	100
WFP-60	65φ	84	63	230	100
WFP-65	70φ	92	68	230	100

• Color : Ivory

• WKP and WFP has grooved cutmark